

# Data Sheet, TIM-3628-50 Hose Reel (Advantage Plus Series)

Medium Pressure (2,000 PSI), powder-coated, single-arm reel,  
1/2" x 50' delivery hose

- HOSE:
  - Working pressure, 2,000 PSI maximum
- SHIPPING:
  - One box
  - Weight: 47 pounds
  - Dimensions: 22.5" x 21" x 9"
- COMPATIBILITY:
  - Oil
  - Automatic Transmission Fluid
  - Antifreeze
- MAXIMUM MOUNTING HEIGHT:
  - 14' above floor
- MOUNTING BASE HOLE PATTERN:
  - 3.5" x 7.5"
  - Four holes for 3/8", Grade 5 hardware
- THREADS:
  - Swivel: 1/2" NPT (F x F)
  - Delivery Hose: 1/2" NPT (M x M)
- WARRANTY (*Defects in material and workmanship, non-wear parts*):
  - Five years for hardware
  - One year for hose
- ACCESSORIES:
  - TIM-3600-50, Slide-in mounting bracket. Four holes for 3/8", Grade 5 hardware
  - TIM-3600-CAB Single Cabinet Enclosure, TIM-3600-PAN End-Panel Kit, TIM-4418-4NS Connecting Hose
  - TIM-4418-2NS Connecting Hose, 1/2" x 1/2" NPT (M x M), 2000 PSI, 2' long
- INSTALLATION RECOMMENDATIONS:
  - Two parallel runs of, Kindorf Strut Channel affixed to steel roofing supports. Four each, 3/8", Grade 5 bolts, flat/lock washers and Kindorf Spring Nuts *per Kindorf pair*
  - Affix TIM-3600-50 bracket(s) to Kindorf pair. Four each, 3/8", Grade 5 bolts, flat/lock washers and Kindorf Spring Nuts *per bracket*. One foot bracket spacing
  - Typical mounting bolt specifications: Grade 5, 3/8-16, 1-1/2" (length as required)
  - Keep reel and associated plumbing away from heat sources
  - Plumbing, 5/8" diameter, seamless steel tubing with steel tubing connectors
  - Three wraps Teflon tape followed by pipe dope

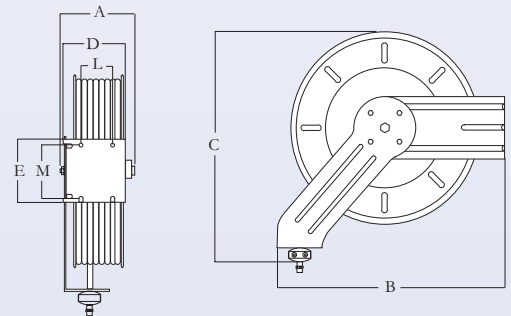

14' maximum mounting height

A	B	C	D	E	Mount L-M
8-7/16"	21-1/2"	20-5/8"	5-3/4"	9"	3-1/2" x 7-1/2"