

Submittal Data Information

Roth DWT 400L



Effective: September 2007

Supersedes:

Job: _____ Engineer: _____ Contractor: _____ Rep: _____

ITEM PART NO.	ITEM DESCRIPTION	MANUFACTURER
#2335103401	110 Gal. (400 Liter) Double Wall Tank	Roth



The Roth Double Wall Safety Fuel Oil Storage Tank (DWT) is made with a seamless blow-molded polyethylene inner tank and a 19 ga. galvanized outer tank. The outer tank is formed by joining cold rolled sheet steel, used to form the sides and bottom from a single piece, with two stamped metal end pieces. The edges between the sides and ends have sealant applied to them and are then rolled to create leak-proof seams. A stamped top is then pressed and riveted into place to complete the assembly of the DWT. The DWT is UL[®] listed in the United States and Canada under SU2258 and approved under NFPA 31 (2001) and CSA B-139-04 as non-metallic fuel oil storage tanks.

Both inner and outer tanks are pressure tested at the factory during assembly according to UL[®] standards and do not require further field testing. The DWT also

comes with a detached saddle base which the tank is placed on at the time of installation.

The tank shall be placed into service in accordance with local codes and the listed use (indoor or outdoor) on a flat, level and stable surface, away from heat sources, corrosive atmospheres or fluids, potential mechanical damage or rapid temperature changes. The final location must have the tank label visible after installation. A minimum of 2" (50 mm) from all walls or obstructions is recommended for normal tank expansion and visual inspection. The integral base support shall not be removed and raising the tank height is not allowed except on a continuous concrete platform at least 6" (150 mm) wider than the tank base at all sides. All local fire code set-backs for fuel oil storage tanks must be observed.

Tanks installed indoors shall not be exposed to direct sunlight on any plastic parts. Tanks installed outdoors shall be assembled with the required cover, Roth #2335100749 for the 400L. All tanks must be installed with an approved vent alarm (Roth Vent Alarm #235000999, or equivalent sized UL listed whistle vent) in order to maintain warranty requirements.

Tank Model	DWT 400L
Nom. Capacity US gal (liters)	110 (400)
Length inches (cm)	29 (110)
Width inches (cm)	28 (72)
Height Inches (cm)	44 (112)
Min Height Req'd inches (cm)	49 (125)
Tank Weight lbs. (kg)	106 (48)
Shipping Weight lbs. (kg)	115 (52)

Your Environment is Our Business.®

ROTH Industries, Inc, 268 Bellew Avenue South, Watertown, NY 13601
ROTH Industries, Inc, 1607 rue de l'Industrie, Beloeil, QC J3G 4S5

Telephone: (315) 755-1011 Fax: (315) 755-1013
Telephone: (800) 969-7684 Fax: (450) 464-7950

Visit our website at: www.roth-america.com

Copyright 2007

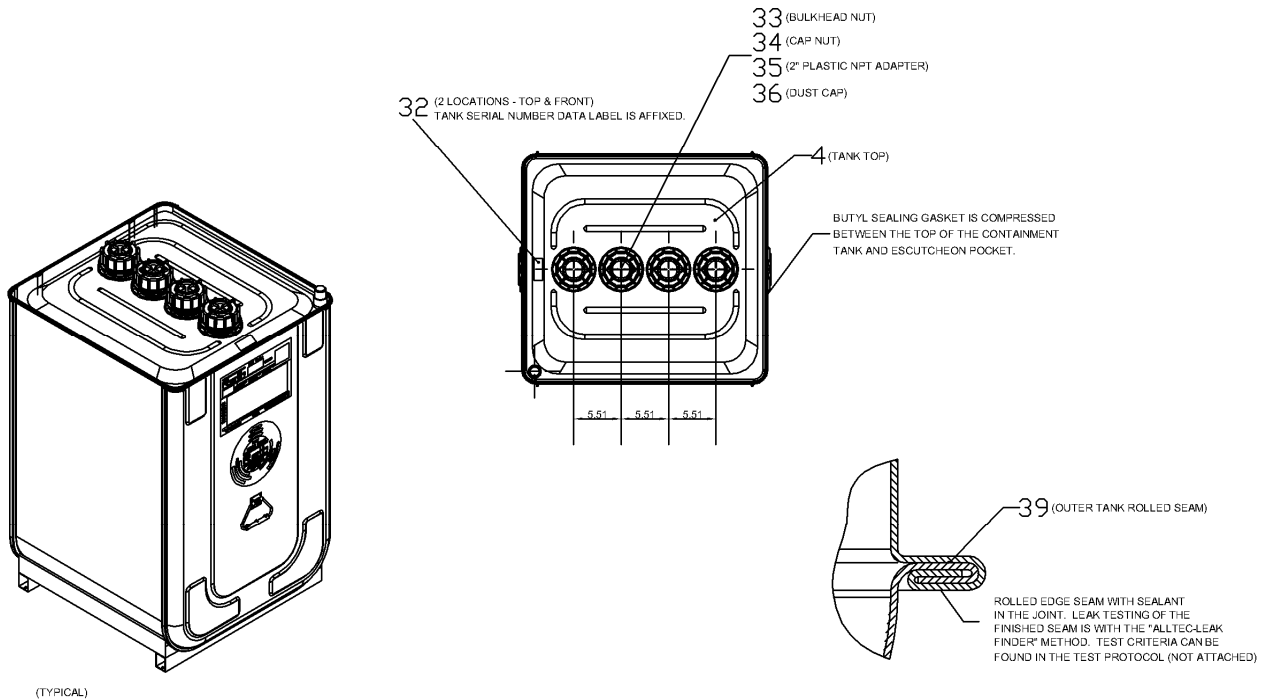
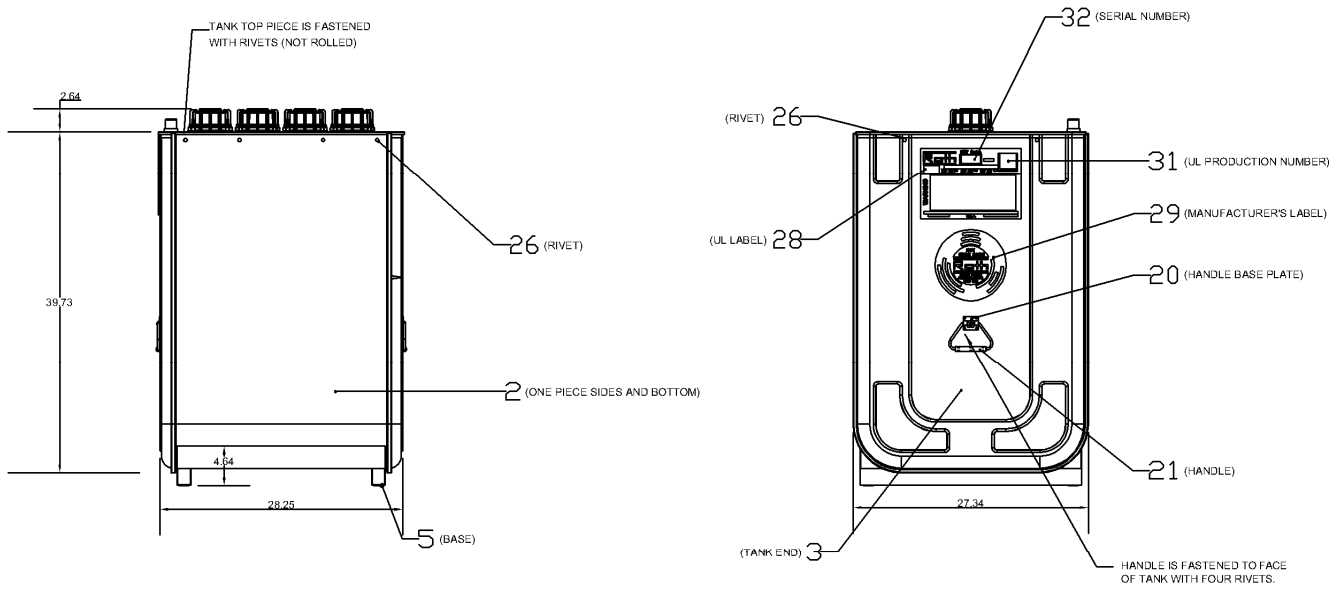

Your Environment is Our Business.®

ROTH Industries, Inc, 268 Bellew Avenue South, Watertown, NY 13601
 ROTH Industries, Inc, 1607 rue de l'Industrie, Beloeil, QC J3G 4S5

Telephone: (315) 755-1011 Fax: (315) 755-1013
 Telephone: (800) 969-7684 Fax: (450) 464-7950

Visit our website at: www.roth-america.com

Copyright 2007